



To be returned before August, 20th 2021

DESIGN YOUR STAND AREA

*« Trust us with the layout and design of your stand.
We are at your disposal to advise you! »*

Your Exhibitor Advisor:
epsecurite.technique@reedexpo.fr

SUMMARY



FLOORING

Technical floor

Carpet

PARTITION

Melamine partitions (storeroom, door)

Wood partitions (storeroom, door)

LIGHTING

Spots

Electrical outlets

SIGN

Decor panels

Signboard

Suspended logo signboard

LIGHTTRUSS

FURNITURE PACKAGES

FLOORING – Technical floor

The technical floor is not a finished floor.

It is mainly used to up-level a stand for utilities (electricity, water, drainage...).

Should you wish to cover it with a parquet floor, lino or other, we recommend using a finishing floor to add to a technical floor.

We remind you that drilling in the technical floor is strictly forbidden.

Do not forget to mention the position of the hatches and access ramp on a scheme.

Technical floor including access ramp: Height : 12cm including 10% of hatches for utilities. Resistance : 350 kg/sqm	€21 Excl VAT / sqm
Access ramp: Module 1x1m	€60 Excl VAT / unit
Finishing floor (to put only on technical flooring) – to be covered (carpet, lino..)	On quotation

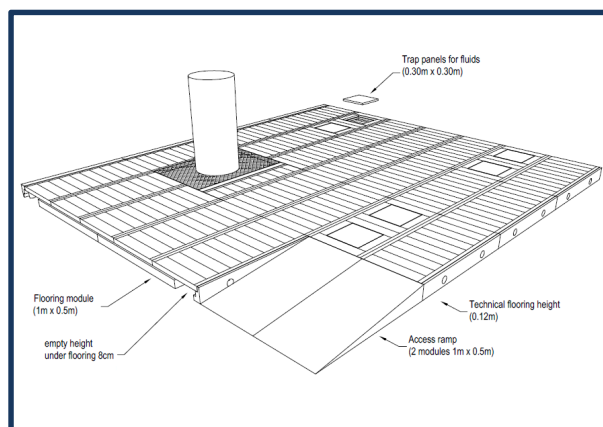

IMPORTANT :

In accordance to the Decree no. 94-86 of January 1994 pertaining to disabled access in premises open to the public, stands comprising a floor must include an access ramp.

FLOORING - Carpet



Tufted carpet is covered by a protected plastic sheet.
 Price includes installation (double sided tape) and removal.
 Back carpet : fireproof impregnated / 100% synthetic fibers.

Tufted carpet	€14 Excl VAT / sqm
Combined offer : tufted carpet + technical floor + access ramp	€35 Excl VAT / sqm

Turquoise 0924	Fushia 9302	Pistachio 9661	Mandarin 9347	Mousy Grey 0915	White 0950
Royal Blue 0824	Petunia 9289	Green Meadow 9631	Buff coloured 0956	Light Grey 0985	
Atoll Blue 1234	Theatre Red 0962	Tomato 9662	Cacao 9248	Graphite 0965	

Melamine partitions

Melamine partitions are hired and must not be painted, drilled, nailed or glued.

White melamine partition 1m or 0.50m x H. 2.40m White melamine reinforced partition to put a screen - 1m	€115 Excl VAT / linear meter €310 Excl VAT / linear meter
Melamine locking door 1m	€165 Excl VAT / unit
Grey aluminium framework Height: 2.40m - white melamine filled (thickness 7mm) - Useful height : 90mm Maximum span without pillar : 4m	€47 Excl VAT / linear meter
Grey aluminium stiffener H. 40mm (maximum span without pillar : 4m)	€22 Excl VAT / linear meter
Straight shelf - 1m x 0.30m	€57 Excl VAT / unit

Grey aluminium stiffener

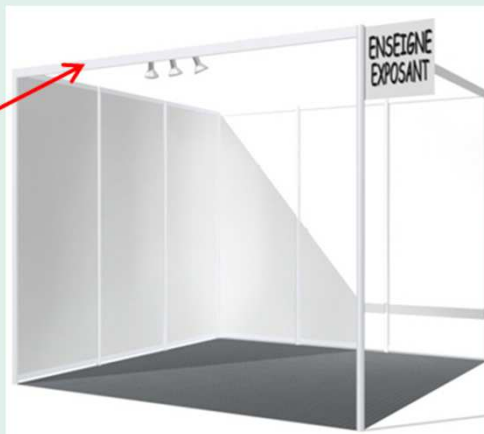

Straight shelf: 30cm depth



STRUCTURES – Technical information

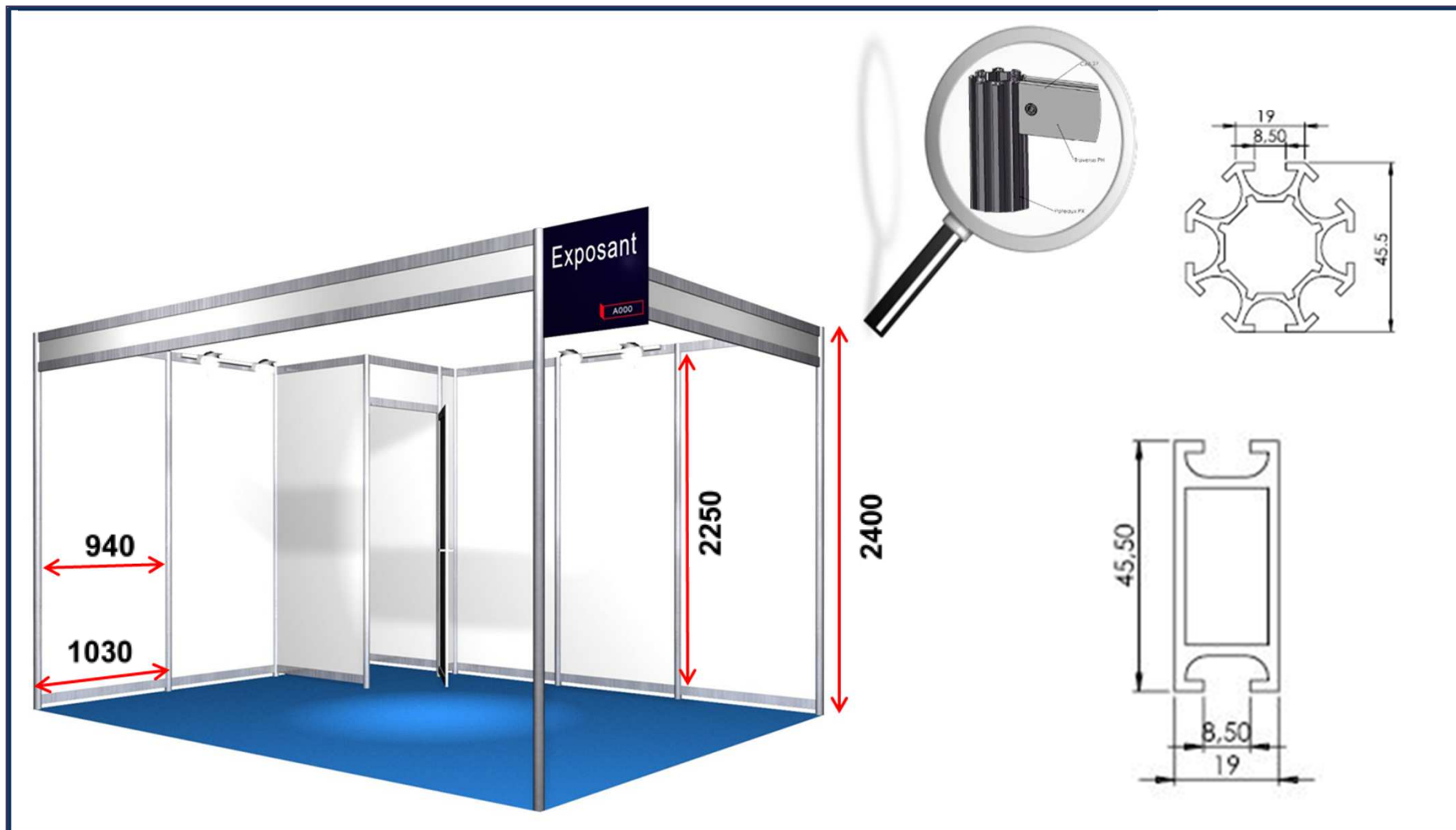

Wood partitions

Wood partitions are hired and must not be painted, drilled, nailed or glued.

Wood partition 1m or 0.50m x H.2.50m covered with brushed cotton (choice of colours below)	€145 Excl VAT / linear meter
White locking wooden door	€220 Excl VAT / unit
Colored locking wooden door (brushed cotton covering)	€275 Excl VAT / unit
Double partition (to nail, screw, glue or paint)	€130 Excl VAT / linear meter
Stiffener covered with brushed cotton	€42 Excl VAT / linear meter

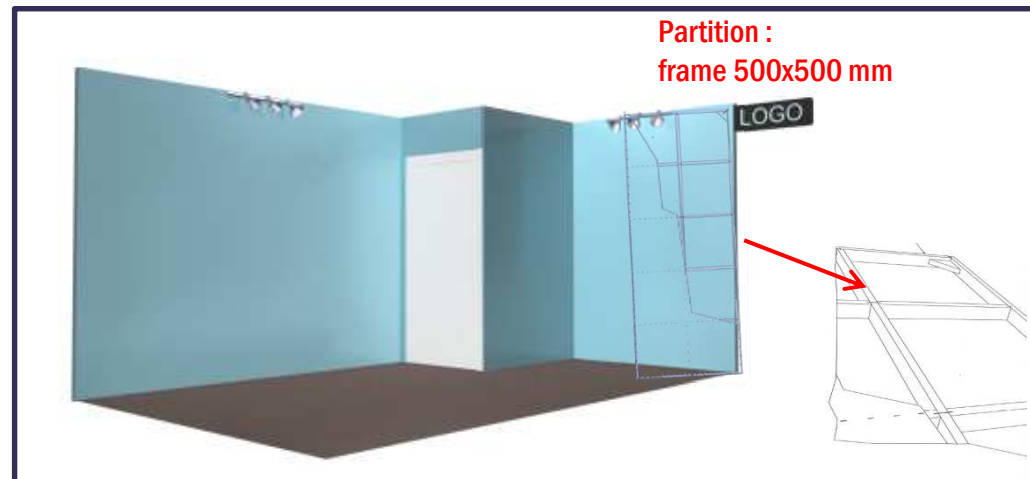



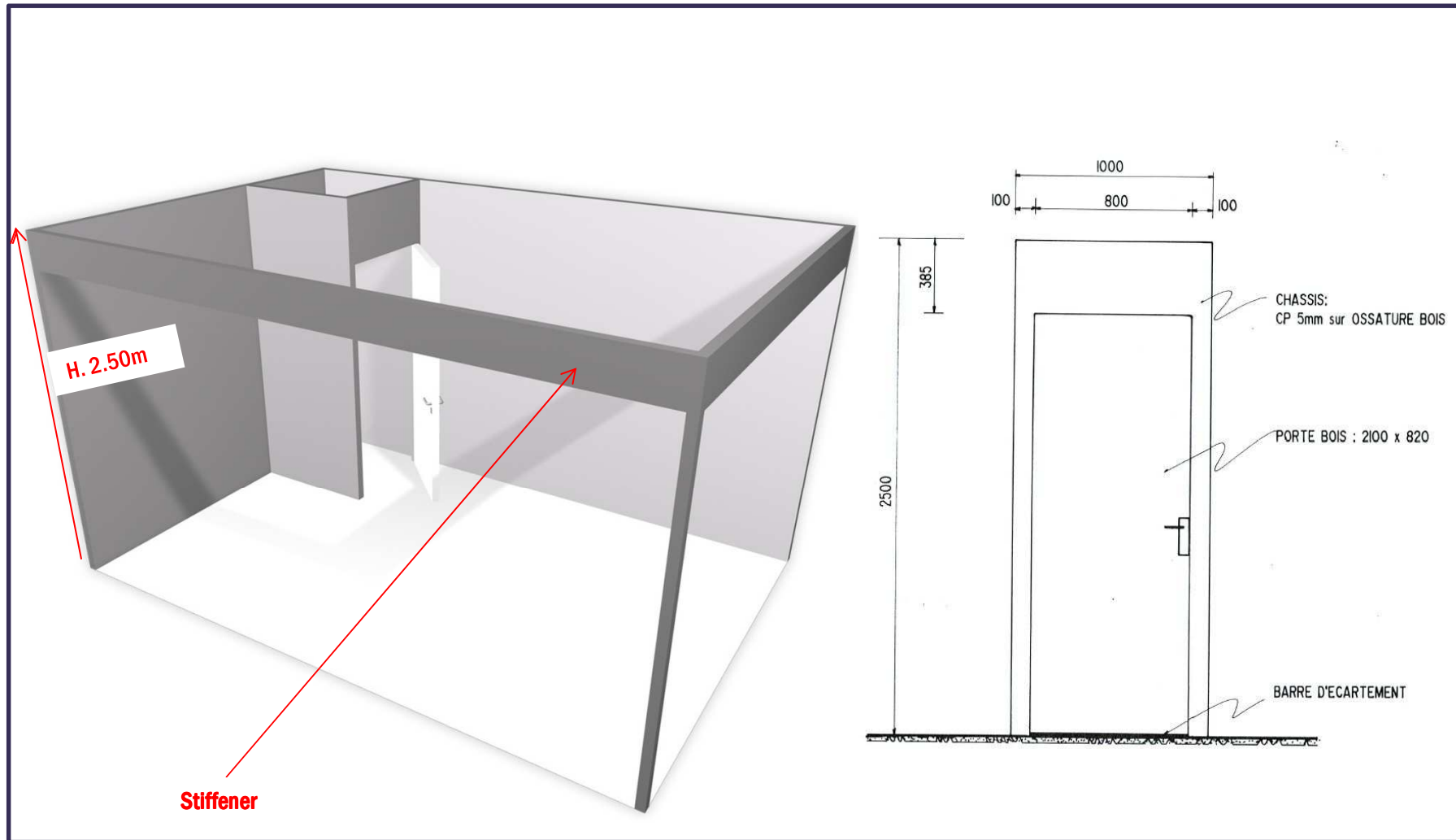

Technical information





Power supply is not included for those fittings (except if you have booked a “ZEN + PACKAGE”)

Electrical switchbox must be ordered to VIPARIS on:

www.viparisstore.com - Tel: +33 (0)1.40.68.16.16

	<p>2, 3 or 4 spotlights track 20w/spot LED</p>	<p>(2 spots) €83 Excl VAT / unit (3 spots) €105 Excl VAT / unit (4 spots) €124 Excl VAT / unit</p>
	<p>Spot low-voltage rod (only for wood partitions) 50w</p>	<p>€110 Excl VAT / unit</p>
	<p>Single electrical outlet connected to the electrical switchbox (power supply non included)</p>	<p>€50 Excl VAT / unit</p>
	<p>3 electrical outlet connected to the electrical switchbox (power supply non included)</p>	<p>€60 Excl VAT / unit</p>





Please send us your high definition visual before August, 20th
 (Illustrator 300dpi)

	<p>Decor panel on modular partitions (adhesive)</p> <p>(Thank you to give us your visual before September 11st, Illustrator - format .eps or .ai o vectorised PDF))</p>	<p>€215 Excl VAT / panel</p>
	<p>Decor panel on wood partitions</p> <p>(Thank you to give us your visual before September 11st, Illustrator - format .eps or .ai o vectorised PDF))</p>	<p>€370 Excl VAT / linear meter</p>
	<p>Visual or logo on your counter</p> <p>Adhesive (80 x 80cm) Printing and installation included</p>	<p>€115 Excl VAT / unit</p>

Please send us your high definition visual before August, 20th
(Illustrator 300dpi)

	<p>Double side sign (only capital letters) Dimensions: 495 x 450mm</p> <p>Oval sign with logo Signboard printed on forex and installed on aluminium stiffener One side - 800 x 350mm</p>	<p>€65 Excl VAT / unit</p> <p>€110 Excl VAT / unit</p>
	<p>Suspended logo or visual - printed on forex - suspended 5m</p> <p>One side - 2 x 1m (installation included) Double side - 2 x 1m (installation included) <i>Others dimensions on demand.</i></p>	<p>€415 Excl VAT / unit</p> <p>€620 Excl VAT / unit</p>
	<p>3D Structure + Sign + Spots</p> <p>3D structure 3lm - suspended 5m + 2 spots + 3 slings Single sided signage - 2 x 1m Double sided signage - 2 x 1m</p> <p>Electricity descent supply (including installation)</p>	<p>€1220 Excl VAT / unit</p> <p>€1430 Excl VAT / unit</p>

Highlight your stand area

	<p>3D structure Slings non included, to be ordered to VIPARIS</p>	<p>€55 Excl VAT / linear meter</p>
	<p>Spot SMD LED, white light 200w</p>	<p>€60 Excl VAT / unit</p>
	<p>PAR spot, warm light 575w</p>	<p>€60 Excl VAT / unit</p>
	<p>Sign installation of your own sign without structure (subject to feasibility) Thanks to bring your sign the first day of the build-up</p>	<p>On quotation</p>
	<p>Laying of hoists in order to leave the 3D structure at man's height for the hanging of a sign</p>	<p>On quotation</p>



Complete your booth with furniture

	<p>Complete Pack WHITE This pack includes 1 counter CHRONOS with key, 1 stool CHRONOS, 1 display MAIA, 1 table NAIADE, 3 chairs MARS and 1 bin. (References of our supplier CAMERUS)</p>	<p>€477 Excl VAT/ unit</p>
	<p>Complete Pack BLACK This pack includes 1 counter CHRONOS with key, 1 stool CHRONOS, 1 display MAIA, 1 table NAIADE, 3 chairs MARS and 1 bin. (References of our supplier CAMERUS)</p>	<p>€480 Excl VAT/ unit</p>
	<p>High table Pack WHITE This pack includes 1 high table ICARE and 3 stools ZEDE (References of our supplier CAMERUS)</p>	<p>€221 Excl VAT/ unit</p>
	<p>High table Pack BLACK This pack includes 1 high table ICARE and 3 stools ZEDE (References of our supplier CAMERUS)</p>	<p>€221 Excl VAT/ unit</p>

Complete your booth with a screen

4K LED Monitor - 3840 x 2160 pixels	€ H.T.	Q
43" (109 cm) - Samsung QM43R - HDMI - Dim. (L. x H.) : 110.3 x 63.8 cm	336	
49" (125 cm) - Samsung QM49N - HDMI - Dim. (L. x H.) : 110.3 x 63.8 cm	408	
55" (140 cm) - Samsung QM55R - HDMI - Dim. (L. x H.) : 123.1 x 70.7 cm	504	
65" (165 cm) - Samsung QM65H - HDMI - Dim. (L. x H.) : 145.6 x 83.4 cm	712	
75" (190 cm) - Samsung QM75R - HDMI - Dim. (L. x H.) : 167.6 x 95.9 cm	888	
85" (216 cm) - Samsung QM85N - HDMI - Dim. (L. x H.) : 190.4 x 109.1 cm	1 472	
98" (249 cm) - Samsung QM98F - HDMI - Dim. (L. x H.) : 219.4 x 124.9 cm	2 160	

Full HD LED Monitor - 1920 x 1080 pixels	€ H.T.	Q
32" (82 cm) - Samsung PM32F - HDMI - Dim. (L. x H.) : 72.1 x 41.6 cm	296	
40" (101 cm) - Samsung ME40C - VGA/HDMI - Dim. (L. x H.) : 92.2 x 54.0 cm	312	
46" (116 cm) - Samsung ME46C - VGA/HDMI - Dim. (L. x H.) : 105.8 x 61.6 cm	376	
75" (190 cm) - Samsung DM75E - VGA/HDMI - Dim. (L. x H.) : 167.6 x 95.9 cm	840	

Mounting System (*)	€ H.T.	Q
Floor stand, middle screen (32" - 65") - Middle screen height : 1,60m (*)	80	
Floor stand, large screen (75" - 85") - Height of top : about 1.8m - 2.2m (*)	128	
Floor stand on castors for 98" screen - Height of top : about 2,40m (*)	208	
Wall mount brackets : included with the monitor, see "important notice"	0	



Important notice

-> Our monitors are wall mounted (brackets included) : a reinforced partition is compulsory. Check with your booth maker, or nearby the organizer of the exhibition.

If your partition is not reinforced / can't be drilled, you need a floor stand

-> Our monitors can read video on USB stick. The video must be MP4 using H264 codec. We can test the video sent 72h (working day) before the opening of the exhibition.

Our technicians will not convert the videos during setup